

# UWB-8

## UNDERWATER JUNCTION BOX



**Material:** Brass  
**8-Way Connection:** (1 for Power, 7 for Lights)  
**Available Finish:** Brass

Overall Dimensions:  
1.58"H x 5.50"W x 5.50"D

Weight: 3.6 lbs

Box Dimensions:  
1.75"H x 5.75"W x 5.63"D

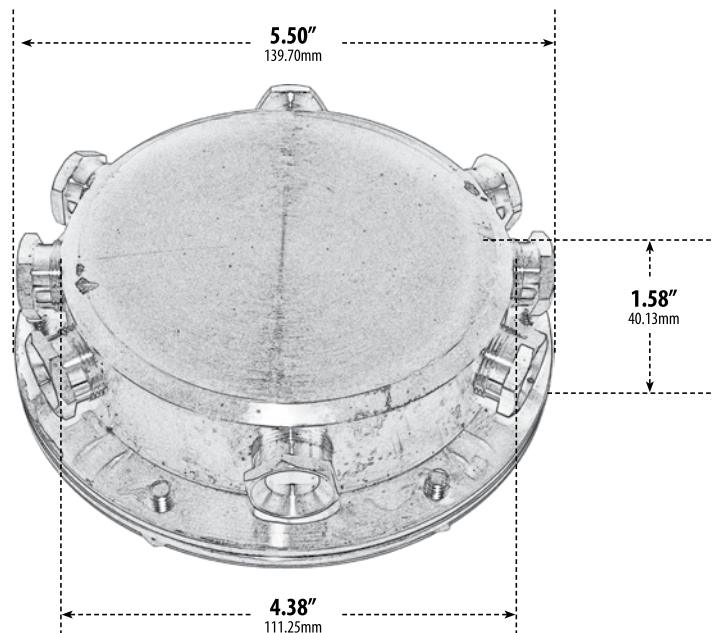

**DABMAR**  
LIGHTING

DABMAR LIGHTING INCORPORATED  
320 Graves Ave . Oxnard, CA 93030 . 805.604.9090 . f: 805.604.9050 . www.dabmar.com  
4693 19th Street Ct E . Bradenton, FL 34203